



الذئبة RACEWAY

UAE ROTAX MAX CHALLENGE 2016-17



Organised by **AL AIN RACEWAY KART CLUB**

In Association With



SERIES SPORTING REGULATIONS VERSION 05.10.16

REGULATIONS

The final text of these Sporting Regulations shall be the English version, which will be used should any dispute arise as to their interpretation. Headings in this document are for ease of reference only and do not form part of the regulations.

1 - GENERAL

The Series and its events shall be run in accordance with the requirements of ATCUAE (incorporating the FIA International Sporting Code and its appendices, the FIA and CIK-FIA official Bulletins, the General Prescriptions applicable to CIK-FIA Karting International Events, CIK-FIA Sporting Regulations 2016, CIK-FIA Technical Regulations 2016, the UAE RMC Technical Regulations 2016/17, these Sporting Regulations and the Supplementary Regulations of each Event of the Series).

All the parties concerned (FIA, CIK-FIA, ATCUAE, Al Ain Raceway, Al Forsan International Resort, Dubai Kartdrome, Muscat Speedway, Yas Marina Circuit and entrants) undertake to apply and observe the rules governing these race events. ANYTHING WHICH IS NOT EXPRESSLY ALLOWED IS FORBIDDEN.

2 - INFORMATION SPECIFIC TO THE CHAMPIONSHIP

2.1 ORGANISER

Al Ain Raceway Kart Club (AARKC)
Al Ain Raceway
P.O. Box 85393
Al Ain
U.A.E
Phone: +971 (0) 3 768 6662
Fax: +971 (0) 3 768 8477
E-mail: admin@alainraceway.com
Web: www.alainraceway.com

✉ P.O.Box 85393. Al Ain. UAE.

☎ +971 (0) 3 768 6662

☎ +971 (0) 3 768 8477

@ sales@alainraceway.com

🌐 www.alainraceway.com

Years

2.2 - DATES / EVENTS

R1:	07 OCT 2016	RCT	AL AIN RACEWAY
R2:	11 NOV 2016	RCT	AL FORSAN INTERNATIONAL RESORT
R3:	12 NOV 2016		AL FORSAN INTERNATIONAL RESORT
R4:	09 DEC 2016	RCT	AL AIN RACEWAY
R5:	10 DEC 2016	RCT	AL AIN RACEWAY
R6:	06 JAN 2017		MUSCAT SPEEDWAY
R7:	07 JAN 2017		MUSCAT SPEEDWAY
R8:	03 FEB 2017	RCT	AL AIN RACEWAY
R9:	04 FEB 2017	RCT	AL AIN RACEWAY
R10:	24 FEB 2017		DUBAI KARTDROME
R11:	25 FEB 2017		DUBAI KARTDROME
R12:	17 MAR 2017	RCT	YAS MARINA CIRCUIT
R13:	07-08 Apr 2017	RCT	AL AIN RACEWAY

RCT = ROTAX CHALLENGE TROPHY EVENT – SEE ALSO ARTICLE 2.7.8

2.3 - PROVISIONAL INFORMATION OF THE MEETING

This is according to each circuit licence and event permit, sanctioned by ATCUAE (ASN). Additional information will be available in the Supplementary Regulations for each meeting. A detailed time schedule for each event will be issued in advance and displayed on the official Notice Board.

Owner driver test sessions are not part of the UAE RMC Championship. Competitors must contact the circuits directly for information on availability and pricing. See also Article 9.

2.4 - ENTRIES:

2.4.1 - Reception Office

Al Ain Raceway Kart Club (AARKC)
P.O. Box 85393
Al Ain, UAE
Phone: +971 (0) 3 768 6662
Fax: +971 (0) 3 768 8477
E-mail: admin@alainraceway.com

2.4.2 - Deadlines:

As per articles 2.2, 2.3, the Supplementary Regulations and Schedule of each event, a correctly completed Entry Form must be received 14 days **before** the race meeting date. The Organisers reserve the right to refuse entries submitted after this deadline.

2.4.3 - Receipt:

Any entry not accompanied by the total fees shall be null and void (see 2.4.5).

2.4.4 - Restriction:

Maximum entries apply in all classes. Entry will be accepted in the order of receipt of the entries. **Note: Entry to Round 13 will be evaluated by the organisation if the competitor concerned has not competed in any previous championship rounds.**

2.4.5 – Fees:

2.4.5.1 – Race Fee:

OPTION 1 – PREPAID ENTRY + TYRES FOR THE 13-ROUND SERIES *SAVE UP TO AED 5,400!*

MICRO MAX	AED 13,900*	[AED 5,400 SAVING]
MINI MAX	AED 14,950*	[AED 5,050 SAVING]
JUNIOR MAX	AED 15,650*	[AED 5,050 SAVING]
MAX	AED 16,000*	[AED 5,400 SAVING]
DD2/MASTERS	AED 16,000*	[AED 5,400 SAVING]

The above totals include Basic Membership Fee plus Entry Fee (all 13 rounds) PLUS 1 set of tyres per round and a 2nd set of tyres for R13 (14 sets total).

* Deadline for advance payment Friday 30th September 2016

All payments non-transferable and non-refundable

To include Premium Membership instead of Basic add AED 700 to the respective total



OPTION 2 – PREPAID ENTRY FEES FOR THE 13-ROUND SERIES *SAVE AED 2.250!!!*

WITH BASIC MEMBERSHIP	AED 5,150#	[AED 2,250 SAVING]
WITH PREMIUM MEMBERSHIP	AED 5,850#	[AED 2,250 SAVING]

Covers Entry Fees for all 13 rounds plus chosen Membership option

Deadline for advance payment Friday 30th September 2016

All payments non-transferable and non-refundable.

See UAE RMC Membership Form for details on Premium Membership benefits

OPTION 3 – PAY AS YOU GO

Basic Membership Fee	AED 500
Premium Membership Fee	AED 1200
Race Entry Fee (2 weeks advance discount)	AED 500
Race Entry Fee (within 2 weeks, no discount)	AED 750
R13 Race Entry Fee (2 weeks advance discount)	AED 900
R13 Race Entry Fee (within 2 weeks, no discount)	AED 1200

* Entry Fee automatically discounted until the 2 week entry deadline

See UAE RMC Membership Form for details on Premium Membership benefits

2.4.5.2 – Supplementary Fees (optional):

Lap time printouts	AED 25
Transponder hire	AED 200
D2 Front tyres (per set)	AED 850
D1 Tyres (per set)	AED 900
D2 Tyres (per set)	AED 950
D3 Tyres (per set)	AED 1000
Tyre fitting (per set)	AED 100

Please note that these are *preferential tyre prices* for pre-ordered tyres paid for as part of the 'pay as you go' option (see 2.4.5.1). Tyres purchased on race day will be subject to availability and charged at premium rates equal to the above amounts plus AED 100 per set (see 4.1).

2.4.6 – Payments:

Payments should be made (in full according to 2.4.2, 2.4.3 and 2.4.5) in cash or cheque, or by direct transfer to:

Account Name	Al Ain Raceway
Bank Name	Abu Dhabi Islamic Bank
Bank Address	AL BATEEN Br, Abu Dhabi, U.A.E
Account Number	1-291975-2
IBAN #	AE-13-050-0000 0000 12919752
BIC/SWIFT CODE	ABDIAEAD

2.5 – COMPETITION REQUIREMENTS:

2.5.1 – Kart Licence:

A. Drivers must be in possession of a valid National or International Kart Licence issued either by ATCUAE or the ASN of another country. If the Entrant is other than the driver then the entrant must hold a separate valid Entrant Licence issued by ATCUAE or the ASN of another country.

B. All competitors holding a licence issued outside UAE must gain "Start Permission" from their licence-issuing ASN.

All competition licences must be surrendered at signing on (along with the start permission paperwork if applicable) for verification. Failure to produce the required documentation will result in enforced non-participation.

C. Competitors within the MENA Zone (but outside UAE) holding a valid National or International Kart Licence issued by a recognised ASN as described in 2.5.1.A may compete and score Championship points within the UAE RMC Championship.

D. Competitors outside the MENA Zone with a National or International Kart Licence issued by a recognised ASN may compete for trophies but will not score Championship points within the UAE RMC Championship.

E. Only drivers from within GCC are eligible to qualify for the Rotax MAX Challenge Grand Finals subject to final approval from ATC UAE.

F. Any applications received that apply to either C or D must apply in advance to both the ATCUAE and Al Ain Raceway Kart Club for starting approval and, if approved, must gain the required "Start Permission" from their licence-issuing ASN.

2.5.2 – Visa:

Entrants and drivers wishing to take part in any International Competition organised abroad can only do so with the approval of the ATCUAE. This authorisation shall be given in such form as they might deem appropriate.

For International Events, all drivers (or parents/guardian/team in case of drivers under 18yrs) must be in possession of a valid Entrants Licence. Further, the minimum licence requirement is Kart International with a valid medical.

2.6 – RACE MEETING FORMATS:

Each race meeting will consist of the following format unless otherwise indicated in the Event Supplementary Regulations or by means of a Bulletin:

FORMAT A – STANDARD

- Signing on
- Scrutineering
- Driver's Briefing
- Practice/Qualifying
- Heat
- Pre-Final
- Final
- Award presentation

2.6.1 – Signing on:

Signing on will commence at the beginning of the event at the time stipulated in the event Schedule and/or Supplementary Regulations.

Drivers must present their valid racing licence and all associated paperwork to be verified by the administration team before being allowed to sign on. Drivers who are unable to produce a valid licence or proof thereof will be referred to the Stewards and may not be permitted to take part in the race meeting.

The event Organiser and the Stewards will control all licences during the event.

For drivers under 18 years, a countersignature is required from a parent or legal guardian.

If a parent is not available to sign he/she must authorise another individual (over 18yrs) to act as the legally responsible adult by obtaining the relevant paperwork IN ADVANCE and submitting it to the organisation as part of the race entry.

Additionally, and optionally, a representative (entrant) may be nominated to accompany the driver at briefings and judicial hearings instead of the parent. This individual MUST also submit their signature at signing on and MUST attend the Driver's Briefing.

2.6.2 – Scrutineering:

Scrutineering will take place in a predetermined area and at the time specified in the event Schedule and/or Supplementary Regulations.

Drivers must first complete a 'Scrutineering Card' and present themselves along with their race wear and kart (which must be ready to race) to the Scrutineers at the allotted time for a basic safety and technical compliance inspection.

The Scrutineering Card will be retained by the Scrutineers throughout the event and referred to as needed. The competitor is solely responsible for ensuring that the information on this card is correct.

Drivers who do not successfully pass Scrutineering will not be permitted to take part in the race meeting. A driver shall not be allowed to change his/her equipment after it has been identified at Scrutineering.

Note: Post-race scrutineering will be conducted at the discretion of the Chief Scrutineer in conjunction with other Senior Race Officials. Drivers are solely responsible for the technical compliance of their kart, engine and race wear at the time of inspection.

WHERE **THURSDAY** REGISTRATION AND SCRUTINEERING IS AVAILABLE, ALL DRIVERS ATTENDING THURSDAY PRACTICE MUST SIGN ON AND/OR SCRUTINEER DURING THIS SPECIFIED WINDOW. RACE DAY REGISTRATION AND SCRUTINEERING ARE RESERVED FOR THOSE UNABLE TO ATTEND THE CIRCUIT ON THURSDAY.

2.6.3 – Drivers' Briefing:

The Entrants' and Drivers' Briefing is a meeting organised by the Clerk of the Course for all Entrants and Drivers entered in the event.

The presence of all drivers and drivers' representatives (as dictated by the signing on paperwork) is mandatory throughout the Briefing under pain of a sanction or even of a possible exclusion from the event. Attendance will be monitored and recorded.

The aim of the Briefing is to remind Entrants and Drivers of points concerning safety and organisation, whether general or specific, and to provide clarification concerning the interpretation of the regulations.

The time of the Briefing is specified in the event Schedule as well as the Supplementary Regulations. Extra meetings may be organised if this is deemed necessary.

2.6.4 – Practice/Qualifying Session:

The length of this session will be stipulated in the event Supplementary Regulations.

All competitors must leave the Pre-Grid at the time of the green flag and complete a minimum of 3 timed laps. Once a driver enters the Pit Lane their session is deemed to be over.

The result of this session will determine the starting positions for the Heat in terms of best lap time classification. In the case of 2 drivers achieving identical best lap times, the Organisers will revert to the second best lap time set by each individual in order to determine priority, and so on (see also 3.7).

Failure to participate in this session may result in exclusion from the remainder of the meeting. Drivers failing to complete the minimum specified distance will be referred to the Stewards.

In the case of transponder failure, the technical flag will be shown (along with the corresponding driver number) as soon as possible after identification of the problem. If the failure is down to human error (transponder missing or uncharged) he/she will remain unclassified. However, if it is determined that the unit itself is faulty, readmission to the session may be authorised once the unit is replaced at the sole discretion of the Clerk of the Course. In this case strict Parc Fermé rules apply.

2.6.5 – Heat:

The length of this race (in laps) will be specified in the event Supplementary Regulations.

The winner of the Heat is the driver completing the stipulated quantity of laps in the shortest time. All drivers crossing the start/finish line behind him/her will be deemed to have finished the race regardless of the number of laps they have completed.

Drivers completing the same number of laps will be classified in the order in which they cross the finish line.

For Format A (standard format) no championship points are awarded. The results of the Heat will determine starting positions for the Pre-Final (see also 3.7).

2.6.6 – Pre-Final:

The length of this race (laps) will be specified in the event Supplementary Regulations.

The winner of the Pre-Final is the driver completing the stipulated quantity of laps in the shortest time. All drivers crossing the start/finish line behind him/her will be deemed to have finished the race regardless of the number of laps they have completed.

Drivers completing the same number of laps will be classified in the order in which they cross the finish line.

The results of the Pre-Final will determine the starting positions for the Final (see also 3.7).

2.6.7 – Final:

The length of this race (laps) will be specified in the event Supplementary Regulations.

The winner of the Final is the driver completing the stipulated quantity of laps in the shortest time. All drivers crossing the start/finish line behind him/her will be deemed to have finished the race regardless of the number of laps they have completed.

Drivers completing the same number of laps will be classified in the order in which they cross the finish line.



2.6.8 – Did Not Start (DNS):

DNS is used to classify any driver who fails to cross the start line at the time of the start signal. See also 2.7.6.

2.6.9 – Did Not Finish (DNF):

DNF is used to describe any driver who fails to cross the finish line to receive the chequered flag. In this case, drivers will be classified in the order of the number of laps completed. See also 2.7.7.

Drivers completing the same number of laps will be classified in the order in which they last crossed the finish line.

2.6.10 – Award Presentation:

Trophies will be presented to the top drivers in each class according to the official finishing positions in the Final. The number of trophies awarded will depend on the total number of class entrants according to the following:

1-3 competitors	1 st place only
4-6 competitors	1 st and 2 nd place only
7+ competitors	1 st , 2 nd and 3 rd places

Results do not become official until 30 minutes “protest time” has elapsed without objection.

Prize winners are to ensure that race suits are worn and zipped up with collar closed. Race boots should also be worn. See also section 8.

2.7 – POINT SCORING:

2.7.1 – Overall Score:

Championship points are awarded for Pre-Final and Final placings only (see 2.7.2 and 2.7.3).

Round 13 will run as an extended format where double points will be available. The exact breakdown of points will be released as either an Event Supplementary Regulation or official Bulletin.

In case a Pre-Final or Final is cancelled because of “force majeure,” no points will be awarded.

In the case of 2 or more drivers finishing the season with the same number of points, the higher place in the Championship will be awarded to the driver with the greatest number of 1st places in Finals. If the number of 1st places is equal then the greatest number of 2nd places will be used, and so on until a winner emerges.

If this procedure fails to produce a result, AARKC Committee will nominate a winner according to such criteria as it deems fit.

At the conclusion of the season, each driver must drop his/her worst 2 overall Round scores to determine an ultimate Championship total. This includes non-attended rounds.

2.7.2 – Pre-Final Points (Format A):

Championship points are awarded as follows:

1 st place	25 points
2 nd place	24 points
3 rd place	23 points
4 th place	22 points
5 th place	21 points ...and so on down to the last place finisher.

2.7.3 – Final Points (Format A):

Championship points are awarded as follows:

1 st place	75 points	7 th place	35 points
2 nd place	65 points	8 th place	32 points
3 rd place	57 points	9 th place	30 points
4 th place	50 points	10 th place	29 points
5 th place	44 points	11 th place	28 points
6 th place	39 points	12 th place	27 points

...and so on down to the last place finisher.

2.7.4 – Did Not Start (DNS):

For the Final the number of championship points awarded equates to 10 points less than the last classified finisher (down to a minimum of zero points).
In the case of Pre-Final DNS, the number of championship points will be 5 points less than the last classified position (down to a minimum of zero points).

2.7.5 – Non-finish (DNF):

In the case of a DNF in any championship-point-scoring race, the number of points awarded will be determined by the driver's classified position (see also 2.6.9).

2.7.6 – Penalties:

Drivers receiving a black flag may be subject to further penalties including, but not limited to, point deductions and fines (see also Article 12).

If the black flag is due to cheating or deemed by officials to be an intentional breach of rules, any points awarded for that race will be deducted from the overall score (minus points). Penalties will apply under ISC Article 12.3 – Scale of Penalties.

2.7.7 – Point Allocation for 'Masters' Drivers:

DD2 and DD2 Master competitors share the same grid and overall points are awarded according to the points system explained above.

Drivers meeting 'DD2 Master' requirements (see Section 3 – Classes and Eligibility) will also take their respective point totals into a separate DD2 Master Championship table. For example, a DD2 Master driver finishing a Final in 3rd place overall will receive 57 points in the overall DD2 classification and also carry this 57 points into the DD2 Master Championship with all other DD2 Master drivers.

This principle will apply also to MAX Master competitors within the MAX category. Points cannot be carried over into another class during the course of the season.

2.7.8 – Rotax Challenge Trophy (RCT):

The Rotax Challenge Trophy (RCT) is a separate 'Club' Championship, running as part of the UAE RMC but consisting of only 8 rounds according to Article 2.2.

Points will be accrued as per the UAE RMC Championship points systems described above (Article 2.7) with the best 7 counting towards a final RCT Championship total.

Drivers subscribing for RCT will automatically score points towards the UAE RMC and are able to enter additional UAE RMC rounds at their discretion. RCT drivers will take their respective UAE RMC point totals into a separate RCT Championship table. For example, a RCT driver finishing a UAE RMC Final in 3rd place overall will receive 57 points in the UAE RMC class classification. He/she will also carry this 57 points into a separate RCT Championship with all other RCT drivers in the same class.

DRIVERS REGISTERED FOR UAE RMC ARE NOT ELIGIBLE TO SCORE POINTS IN RCT.

In the exceptional situation that a registered RCT competitor finishes 1st, 2nd or 3rd in the overall UAE RMC Championship, he/she will forfeit their position in RCT.

2.7.8.1 – Rotax Challenge Trophy Fees

PLEASE NOTE THE DEADLINE FOR RCT ADVANCE PAYMENTS LISTED BELOW IS **FRIDAY 30TH SEPTEMBER 2016** AND ALL SUCH PAYMENTS ARE NON-TRANSFERABLE AND NON-REFUNDABLE.

FOR STANDARD PAYMENTS AND SUPPLEMENTARY FEES SEE ARTICLE 2.4.5 AND 2.4.6.

OPTION 1 – PREPAID ENTRY + TYRES FOR THE 8-ROUND SERIES **SAVE UP TO AED 3,525!**

MICRO MAX	AED 9,025*	[AED 3,525 SAVING]
MINI MAX	AED 9,700*	[AED 3,300 SAVING]
JUNIOR MAX	AED 10,150*	[AED 3,300 SAVING]
MAX	AED 10,375*	[AED 3,525 SAVING]
DD2/MASTERS	AED 10,375*	[AED 3,525 SAVING]

The above totals include Basic Membership Fee plus Race Entry Fees (all 8 rounds) PLUS 1 set of tyres per round and a 2nd set of tyres for the final 2-day event (9 sets total). To include Premium Membership instead of Basic add AED 700 to the respective total

OPTION 2 – PREPAID ENTRY FEES FOR THE 8-ROUND SERIES **SAVE AED 1,500!**

WITH BASIC MEMBERSHIP	AED 3,400#	[AED 1,500 SAVING]
WITH PREMIUM MEMBERSHIP	AED 4,100#	[AED 1,500 SAVING]

Covers Entry Fees for all 8 rounds plus chosen Membership option (see UAE RMC Membership Form for details on Premium Membership benefits).



2.8 – STARTING PROCEDURES:

2.8.1 – General:

Starts may be either 'standing' or 'rolling'. The regulations for "Rolling starts for direct drive karts with or without clutches" or "Standing starts for karts with gearboxes" of the CIK-FIA General Prescriptions will apply accordingly.

Kart trolleys will not be permitted onto the circuit from the moment the karts leave the Grid to the time all running karts have returned to the pits following the chequered flag.

2.8.2 – Pre-Grid:

Karts shall be lined up on the Pre-Grid as detailed in section 2.6. It is the driver's responsibility to ensure that both he/she and their kart are in position on the Pre-Grid before the Pre-Grid closes. Any drivers arriving after this time will not be permitted to enter the circuit without the express permission of the Clerk of the Course.

Only one helper (mechanic) is permitted to accompany the driver/kart onto the Pre-Grid. Other than that, the Pre-Grid is out of bounds to all personnel who are not operating in an authorised capacity as signed-on Officials.

Karts placed on the Pre-Grid must be ready to race. It is strictly forbidden to carry out any work and/or set-up on the kart on the Pre-grid with the exception of tyre pressures, which can be adjusted by the driver or his/her mechanic and by using his/her own means.

Anyone wishing to carry out work after the kart has been placed on the Pre-Grid must completely remove the kart beyond the last placed kart on the Pre-Grid before carrying out such work.

Mechanics must clear the Pre-Grid 1 min before the start of the Race ("1 minute" board).

30-seconds after the "30 seconds" board is displayed the green flag will be shown at the front of the grid to indicate that the karts must proceed onto the circuit to either commence Practice/Qualifying or to begin a Formation Lap.

Should a driver require assistance after the green flag is shown a mechanic may only work on the kart once the other karts have left the Pre-Grid.

If a driver is unable to start from the Pre-Grid at the time of the green flag, he/she will only be authorised to join the circuit on the orders of the Clerk of the Course.

2.8.3 – Formation Lap:

Drivers should leave the Pre-Grid when the green flag is displayed.

The field must stick together in 2 distinct lanes as per the positions on the Pre-Grid. It is the responsibility of the driver in Pole Position to set the pace, which should be steady and controlled. The driver in 2nd position should remain alongside during this lap.

Drivers must not break formation before taking the start (see 2.8.4). Erratic weaving (zig-zags) is prohibited. Offending drivers will be penalised.

The number of Formation Laps shall be indicated during the Briefing. It is forbidden to overtake another driver under pain of a penalty inflicted by the Stewards.

If a driver stops for any reason during the Formation Lap and the kart cannot be restarted quickly, it must be immediately removed from the track to a place of safety.

A driver who is otherwise delayed and finds themselves out of position will have the possibility of regaining his/her place (1) only if this manoeuvre does not impede other drivers and (2) in all cases before having reached the Red Line which will be marked on the track and indicated by the Clerk of the Course during the Briefing.

In order to regain one's position, it is forbidden to use any course other than the track used during the race.

Any driver permitted to join the track AFTER a false start MUST remain at the back of the grid on the current formation lap and any subsequent formation lap until the race is officially started. See also 2.8.5.

It is the responsibility of Pole Position to keep the field at walking pace from the red line up until the tramlines in the interests of safety. Anti-Pole must ensure that he/she is not ahead of Pole Position at the time the start signal is given.

Additional Formation Laps required due to aborted starts may be deducted from the race distance at the discretion of the Clerk of the Course.

2.8.4 – Race Start (Rolling):

At the end of the Formation Lap, drivers will proceed forward in two lines at a reduced and constant speed towards the Starting Line, as dictated by the front row. Each line of karts shall remain within the 110m long corridor (tramlines) marked on the track.

When the karts approach the Start Line the red lights will be on. Karts must maintain their position until the start signal is given.

A driver crossing the tramlines is liable to be sanctioned by the Stewards on the basis of a time penalty of 3 seconds for partially crossing the lines and 10 seconds for completely leaving the corridor.

If he/she is satisfied with the formation, the Starter will give the start by switching off the red lights. If he/she is not satisfied with the procedure flashing amber lights will be activated (with the red lights) to indicate a “no-start”, meaning that an extra Formation Lap will take place. If the reason for a “no-start” is due to a particular offender, Officials may decide to impose a penalty at their discretion.

If he considers that a driver has been immobilised as a result of another driver’s mistake, the Clerk of the Course may stop the Formation Lap and recommence the Starting Procedure on the basis of the original grid or allow the impeded driver to regain his/her position.

In the case of start light failure, the National flag will be used. The flag will be held out stationary on the approach and raised to indicate a start.

As soon as the start signal has been given racing conditions are applied.

The Clerk of the Course assumes responsibility for determining the safest way to deal with stranded karts/drivers once the race is live. Under his direction the marshals will sometimes assist driver(s) to a place of safety before transferring the kart(s) to a safe position although it should be noted that this is the driver’s responsibility. Alternatively, in certain circumstances he may (in the interests of safety) direct that karts are separated/manoeuvred so that the drivers can continue. Only registered officials may assist.

2.8.5 – False Start:

A false start will be indicated by one or both of the following:

- A flashing amber “first corner light”
- A false start flag (green with yellow chevron) displayed after the Start Line

In either of these circumstances, competitors are expected to raise one arm in acknowledgement of the false start before slowing and organising themselves into their original starting positions to attempt a restart at the next opportunity.

Any competitors forced to take the [false] start out of position following a pre-grid or formation lap delay may not assume their original grid position. Drivers permitted to join the grid AFTER a false start MUST remain at the back of the field until the race is officially started.

2.8.6 – Jump Start:

Any attempts to jump the start or delay it and any karts leaving the lane (rolling start) or grid slot (standing start) before the lights are switched off shall be sanctioned according to Article 2.24 of the CIK General Prescriptions.

2.9 – RACE NEUTRALISATION (FULL COURSE YELLOW):

The Clerk of the Course may decide to ‘neutralise’ a Race or Qualifying session by directing that a *full course yellow* be issued. This procedure can be used where the track is obstructed and/or drivers and officials are in immediate physical danger BUT the circumstances are insufficient to justify a stoppage (see Article 2.10).

Simultaneously, yellow/black quartered flags will be shown at all Marshals’ Posts, accompanied by a ‘SLOW’ board where available. Yellow warning lights will be activated at circuits with this capability. The race leader’s number will be displayed at the start line. [At venues where yellow/black flags are unavailable, **stationary** yellow flags will be used.]

The leading kart will dictate the pace but must slow sufficiently to allow all karts behind to catch up and form a long train. The formation should then remain as tight as possible with no overtaking permitted (unless a kart slows dramatically or stops because of a problem).

At the end of the neutralisation, the Clerk of the Course will call for the yellow lights to be switched off. A waved green flag at the Start Line will signal the resumption of the race. Green flags will then be shown at all Marshal Posts for a maximum of 1 lap.

Drivers should remain in single file on the approach to [the green flag at] the Start Line and may accelerate only after crossing the yellow line. Overtaking remains prohibited until crossing the Start Line at the time of the green flag.

Each lap completed during the neutralisation will be counted as a racing lap. If the race finishes during the neutralisation, the karts will take the chequered flag as usual.

2.10 – RACE STOPPAGE:

Should it become necessary to stop a Race or Practice because the circuit is blocked by an accident or because weather or other conditions make it dangerous to continue, the Clerk of the Course or the Race Director shall order a red flag to be shown at the Start Line.

Simultaneously, red flags will be shown at all Marshals' Posts. The decision to stop the race or practice may be taken only by the Clerk of the Course (or by his deputy) or the Race Director. If the signal to stop racing is given all karts will immediately reduce their speed and come to a stop on the track at the place designated during the Briefing, considering that the classification of the Race will be the classification at the end of the lap prior to that during which the signal to stop was given.

The procedure to be followed varies according to the number of laps completed by the Race leader before the signal to stop was given:

2.10.1 – Less than 2 laps complete:

If less than 2 laps have been completed by the leader, the Race will either be re-run in its entirety or abandoned, in which case the result becomes null and void.

2.10.2 – More than 2 laps but less than 75% complete:

If more than 2 laps but less than 75% of the distance scheduled for the Race has been completed by the leader (rounded up to the nearest whole higher number of laps), the Clerk of the Course shall, at his discretion, decide to:

- a) Abandon the race. In this case the race result shall be declared as the finishing order behind the leader on the last full lap completed by him/her and before the race was stopped.
- b) Consider the race suspended and run it as a two-part race. In this case, the Race will be restarted as a single-file rolling start. Resuming start positions will be determined by the finishing order at the end of the lap before the one on which the race was suspended. Drivers "one lap down" shall be put in their correct position behind the drivers on the lead lap. The race distance shall be the number of laps required to make up the full race distance. The finishing order of the second part shall be the finishing order of the race.
Drivers "one lap down" in the first part shall be deemed to have finished the race 1 lap down unless they 'unlap' themselves.

While racing is stopped, the whole course shall be considered as Parc Fermé and no work may be carried out on any kart. No one may enter the circuit without the express permission of the Clerk of the Course.

If a kart leaves the circuit during the stoppage it will not be permitted to rejoin the race.

Any kart not racing before the incident (that caused the stoppage) shall not rejoin the restarted race.

Karts involved in the incident that gave rise to the stoppage, or who subsequently stopped racing prior to the displaying of the red flag, may only rejoin the race if the Clerk of the Course, in consultation with the Chief Scrutineer, is satisfied that a kart is safe to continue without repair, and the Chief Medical Officer is satisfied that a competitor is fit to continue racing. Any such individual must restart at the rear of the field.

All other karts may take the restart in their appropriate position.

Exceptionally, if it becomes necessary to remove all karts from the circuit before the restart, Parc Fermé conditions apply and no work or repair may be carried out without the express consent of the Chief Steward or Clerk of the Course. This will be discretionary.

2.10.3 – More than 75% complete:

If 75% race distance or more has been completed by the leader (rounded up to the nearest whole higher number of laps), the Race will be deemed to have ended. The race result shall be declared as the finishing order behind the leader on the last full lap completed by him/her and before the Race was stopped.

2.11 – RACE FINISHING PROCEDURES:

A. The chequered flag signal indicating the end of the Race shall be given on the Start Line as soon as the leading kart has covered either the full race distance or the greatest distance during the time scheduled for the race.

B. Should the signal indicating the end of the race be given before the leading kart completes the scheduled number of laps or before the prescribed time has elapsed, the race will be deemed to have finished when the leading kart last crossed the Line before the signal was given.

Should the signal indicating the end of the race be delayed for any reason, the Race will be deemed to have finished when, under normal circumstances, the end of the race would have been decided if there had been no delay.

C. After having received the chequered flag, all karts shall directly go to the scales (and Parc Fermé) using the normal course of the track, without any unnecessary delay, without performing doughnuts, without stopping, without giving or receiving any object whatsoever and without any help (except that of Marshals if necessary).

Any classified kart unable to reach the scales by its own means will be placed under the control of Marshals, who will supervise the movement of the kart to the scales with the assistance of the driver.

D. For a finish to be considered valid, a driver must have crossed the Finish Line seated at the wheel of his/her kart and under his/her own power.

E. Any driver removing both hands from the steering wheel whilst travelling at considerable speed, whether in celebration or not, will be adjudged to be driving dangerously and will be referred to the Stewards.

F. In the case of a dead heat on the Finish Line revealed by timekeeping, the rule for deciding between tying drivers shall be the fastest lap time recorded by each driver during the race concerned.

2.11.1 – Weighing Scales:

The official weighing scales will be situated in Parc Fermé unless otherwise stipulated by the circuit licence.

The scales must undergo annual certified calibration. Additionally, 5 individual check weights totalling 100 kg should be used at each meeting to verify the accuracy of the scales.

The Chief Scrutineer will be the judge of fact in all post-race weigh-ins. If a competitor is found to be underweight, the Chief Scrutineer will issue a report to the Chief Steward based on the series of weighing measurements taken in Parc Fermé. Any final decision relating to classification in this instance will be taken by the Chief Steward.

2.11.2 – Parc Fermé:

Only authorised Officials may enter Parc Fermé. No intervention of any kind is allowed there unless authorised by such Officials.

When Parc Fermé is in use, Parc Fermé regulations will also apply in the area between the finishing line and the Parc Fermé entrance.

Parc Fermé shall be sufficiently secure so that no unauthorised person can gain access to it.

Any driver returning to Parc Fermé either during or after a race (for whatever reason) must report to the scales for weight verification.

Drivers are not permitted to leave Parc Fermé until expressly permitted by the Officials.

3 – CLASSES AND ELIGIBILITY

3.1 – MICRO MAX:

3.1.1 – Age Limits:

Age range 8-11 yrs.

Competitors must be at least 8 years of age. Exceptionally, 12 year old drivers are eligible if under 145cm in height and 32kg in weight.

3.1.2 – Weight Limit:

Minimum weight of kart + driver (in full race gear) is **110 kg**

Recommended minimum driver weight is 24kg

3.1.3 – Numbers:

Yellow plate (22cm sides) with black numbers (at least 15cm high with 2cm stroke)

Range of numbers 1 to 99.

1 is reserved for the reigning UAE RMC Micro MAX Champion only. Number requests must be confirmed by series organisers.

3.2 – MINI MAX:

3.2.1 – Age Limits:

Age range 11-14 yrs.

Competitors must be at least 11 years of age.

Exceptionally, 10 year old drivers are eligible to compete if they (1) are at least 145cm in height, (2) weigh at least 35kg, (3) have completed at least one full season in the Micro MAX category during the previous UAE RMC season, and (4) their registration is accepted by the series organisers.

3.2.2 – Weight Limit:

Minimum weight of kart + driver (in full race gear) is **135 kg**

Recommended minimum driver weight is 32kg (11yrs+)

3.2.3 – Numbers:

Yellow plate (22cm sides) with black numbers (at least 15cm high with 2cm stroke)

Range of numbers 100 to 199.

100 and 101 are reserved for the reigning UAE RMC Mini MAX Champion only. Number requests must be confirmed by series organisers.

3.3 – JUNIOR MAX:

3.3.1 – Age Limits:

Age range 13-16yrs

Competitors must have their 13th birthday before/during 2017 and have their 17th birthday after 31/12/17.

12 year old drivers are eligible to compete if they (1) satisfy weight/height requirements given in 3.2.1, (2) have completed at least one full season in the Micro or Mini MAX category during the previous UAE RMC season, (3) conform to the birthdate restrictions given above and (4) have their registration is accepted by the series organisers.

3.3.2 – Weight Limit:

Minimum weight of kart + driver (in full race gear) is **145 kg**

Recommended minimum driver weight is 40kg (recommended minimum height 145cm)

3.3.3 – Numbers:

Yellow plate (22cm sides) with black numbers (at least 15cm high with 2cm stroke)

Range of numbers 200 to 299.

200 and 201 are reserved for the reigning UAE RMC Junior MAX Champion only. Number requests must be confirmed by series organisers.

3.4 – MAX:

3.4.1 – Age Limits:

Age range 15yrs+

Exceptionally, 14 year old drivers are eligible to compete if they (1) are in the calendar year of their 15th birthday, (2) weigh at least 60kg and (3) have completed at least one full season in the Junior MAX category during the previous UAE RMC season.

3.4.2 – Weight Limit:

Minimum weight of kart + driver (in full race gear) is **165 kg**.



3.4.3 – Numbers:

Yellow plate (22cm sides) with black numbers (at least 15cm high with 2cm stroke)
Range of numbers 300 to 399.

300 and 301 are reserved for the reigning UAE RMC MAX Champion only. Number requests must be confirmed by series organisers.

3.4.5 – Front Brakes:

Front brakes are not permitted.

3.4.6 – MAX Master:

Drivers wishing to be considered in a domestic MAX Master category must be at least 31 yrs and have their 32nd birthday before or during 2017.

3.5 – DD2:

3.5.1 – Age Limits:

Age range 15yrs+

Exceptionally, 14 year old drivers are eligible to compete if they (1) are in the calendar year of their 15th birthday, (2) weigh at least 60kg and (3) have completed at least one full season in the Junior MAX category during the previous UAE RMC season.

3.5.2 – Weight Limit:

Minimum weight of kart + driver (in full race gear) is **175 kg**

3.5.3 – Numbers:

Yellow plate (22cm sides) with black numbers (at least 15cm high with 2cm stroke)
Range of numbers 400 to 499.

400 and 401 are reserved for the reigning UAE RMC DD2 Champion only. Number requests must be confirmed by series organisers.

3.6 – DD2 MASTER:

3.6.1 – Age Limits:

Age range 31yrs+

Competitors must be at least 31 yrs and have their 32nd birthday before or during 2016.

3.6.2 – Weight Limit:

Minimum weight of kart + driver (in full race gear) is **175 kg**

3.6.3 – Numbers:

Yellow plate (22cm sides) with black numbers (at least 15cm high with 2cm stroke)
Range of numbers 500 to 599.

500 and 501 are reserved for the reigning UAE RMC DD2 Master Champion only. Number requests must be confirmed by series organisers.

3.8 – ENGINES:

Engines as per UAE RMC Technical Regulations 2016/17.

Only engines provided by and sealed by the official UAE Rotax Distributor or one of their official appointed Service Centres are eligible for use. See also 5.2.6.

3.8 – NOVICE DRIVERS:

A competitor will be considered as a 'Novice' and must carry Novice plates until he/she has obtained three kart race signatures from the Clerk of the Course. Novice drivers will occupy the rearmost grid positions in all Heat and Pre-Final races, notwithstanding his/her qualifying performance. Pre-Final classification will be carried over to the Final.

New RMC competitors with valid licence history should apply to ATC UAE for clearance to run without novice plates.

The novice plate must be a 22cm square yellow sticker or yellow plastic plate (plastic plate must have rounded off corners as per CIK regulations) with a black 'X' running from corner to corner (2-3cm stroke width). It must be displayed on the rear bumper alongside the regular race number plate.

3.9 – OTHER CLASSES:

AARKC Bambino Championship may run alongside UAE RMC Race Meetings held at Al Ain Raceway and other guest venues. This is a Club class with its own regulations operated by AARKC and does not enjoy National Championship status.



4 – ORGANISER'S SUPPLEMENTARY PROVISIONS

4.1 – TYRES:

4.1.1 – Eligible Tyres:

Only the following tyres may be used:

- MOJO D2 (4.5/10.0-5 front tyre only) – Micro MAX
- MOJO D1 – Mini MAX
- MOJO D2 – Junior MAX
- MOJO D3 – MAX, DD2, DD2 Master

In the exceptional event that insufficient quantities of these tyres are available, the organisers reserve the right to provide a suitable substitute tyre in consultation with ATC UAE. Competitors will be notified of any such changes in the Supplementary Regulations applying to the meeting.

4.1.2 – Quantity of Tyres Permitted:

For each single-day race event (from Practice to the end of the Final), the maximum number of slick tyres, new or used, permitted is 1 complete set (2 front, 2 rear). Exceptionally, Round 13 follows an extended format. For this event only, the maximum number of slick tyres is 2 complete sets (4 front, 4 rear).

4.1.3 – Pre-Ordering of Tyres:

New tyres should be ordered in advance by completing the relevant section of the Race Entry Form according to individual requirements. These must be paid for with the Entry Fee (see 2.4)

Tyres may be available on race day but they will be subject to a premium so competitors are strongly advised to pre-order and prepay for tyres.

4.1.4 – Tyre Fitting:

The Organisers warmly encourage competitors to develop the skills needed to fit their own tyres to rims but should at all times guard against using inappropriate substances to assist this process. Tyre soap is acceptable but should be applied to the tyre beads only. Competitors are reminded that the application of tyre softeners is against the rules and evidence of this or any other substance across the tread face of a tyre will inevitably result in disqualification from the Race Meeting and further sanctions.

4.1.5 – Tyre Marking:

Each tyre, whether new or used, will be marked in advance by the Organisers. Additionally, the Chief Scrutineer will, at his discretion, mark these same tyres during Scrutineering. The markings will vary from race to race to reduce the possibility of falsification (cheating).

It is mandatory to use marked tyres during every session of the race meeting. Tyres will be checked for markings throughout the day.

It is the responsibility of the driver to ensure that he/she participates in all sessions with marked tyres. Any competitor found to be competing on tyres without the proper markings, or deemed by the Panel of Stewards to have deliberately attempted to falsify such markings in an attempt to gain an unfair advantage, will be excluded from the race and may be excluded from the entire meeting.

4.1.6 – Tyre Collection:

According to pre-orders (see 4.1.3), batched and marked tyres will be made ready for collection at the time indicated in the Supplementary Regulations for the event. Competitors should double-check that each tyre is marked clearly and appropriately at the time of collection.

WHEN SCRUTINEERING ON RACE DAY (RATHER THAN IN ADVANCE) IT IS THE RESPONSIBILITY OF THE COMPETITOR TO ENSURE THAT HE/SHE PRESENTS HIS/HER KART AT SCRUTINEERING WITH MARKED RACE TYRES.

4.1.7 – Tyre Replacement:

Additional tyres are not usually available throughout the meeting in accordance with 4.1.2 and 4.1.3. However, in the event of a tyre sustaining accidental damage (e.g. puncture) it must be presented for inspection to the Chief Scrutineer who will be responsible for deciding whether a replacement tyre can be issued by the organisation (see also 4.1.5). Where this is permitted, the replacement tyre must be fitted to exactly the same corner of the kart as the tyre that sustained the damage.

4.1.8 – Long-term Use:

Competitors wishing to use tyres at the following race meeting may do so by leaving them in the control of the Organisers at the end of the race meeting according to the following strict protocol **BEFORE** the trophy presentation (30 mins after the last RMC class Final):

- (1) Remove race tyres from kart and place them in a suitable tyre bag (see 4.1.4). **Note: other bags are not acceptable due to handling/storage difficulties.**
- (2) Ensure that each bag is clearly and indelibly marked on the outside with the competitor name and number.
- (3) Hand over the bagged tyres to the appropriate Al Ain Raceway representative. The organisers will not accept responsibility for any bags/tyres not handed over properly, e.g. dumped randomly near to the organisation base.

These bagged tyres/rims will be kept in controlled conditions by the Organisers, re-marked and handed back to the competitor **at the following round.**

The organisers will not store/transport tyres/rims and will not accept responsibility for these items beyond this point. Competitors unable to collect used tyres at this pre-arranged time must nominate someone else to collect them or risk them being discarded.

The administrative charge to cover tyre collection, handling, transport, storage, remarking and redistribution is AED 150. This payment is non-transferable and non-refundable and **MUST** be paid along with the Race Entry Fee for the following race meeting.

Therefore, for double-header rounds anyone wishing to use the same set of tyres over both event days will need to include AED 150 payment within the Entry Fee of the 2nd day.

Long term use is **NOT** an option from Round 5 to Round 6 and from Round 7 to Round 8 due to the costs associated with transporting used tyres across the UAE border.

Note: During re-marking, the Organisers may employ chemical treatment detectors, e.g. tyre sniffers. If the Organisers suspect that a tyre has been treated or tampered with in any way, the tyres will be removed from use. If investigation reveals an underlying attempt to deliberately cheat, further action will be taken against the competitor or entrant in line with recommendations of the International Sporting Code through ATCUAE.

Because of the advance preparation required to re-mark tyres for future race meetings, this provision will NOT be available for late entries. New tyres must be purchased from the race organisation.

4.2 – FUEL (SUBSTITUTION):

In the interests of consistency and fair play any competitor at any time, at the discretion of the Senior Officials, may be asked to present his/her kart with fuel tank and all fuel lines empty. Premix petrol will then be supplied to that competitor for use in that race. Petrol will be from the local supplier/pump (95-98 octane lead free).

4.3 – TRANSPONDER:

4.3.1 – Transponder Hire:

Transponder hire will be charged at AED 200 per day and transponders will be distributed at signing on. A deposit will be required at the time of hire. This may be in the form of cash/cheque to the value of AED 1750, the competitor's valid Race Licence or another acceptable item of value as specified in the Supplementary Regulations.

The driver/entrant is liable for the full cost of the transponder (AED 1750) and clip (AED 50) in the event of any loss or damage sustained during the hire period, howsoever caused.

There are a limited number of transponders available for hire. These will be allocated as Entry Forms are received on a first-come, first-served basis.

Any entry received after all hire transponders are allocated will need to buy a transponder.

4.3.2 – Transponder Purchase:

Transponders are available for purchase at AED 1750 per unit. This includes charger, user manual and fixing kit. Please check in advance with the race organiser for availability.

4.3.3 – Transponder Fitting:

The transponder must be mounted in an approximately upright position (i.e. the "R" clip at the top) on the back of the seat.

It should be secured at a height of 25cm ±5cm. This height can be measured from the ground to any part of the transponder.



4.3.4 – Transponder Failure:

It is the driver's responsibility to ensure that the transponder is fitted securely and in the correct position at all times when racing, as well as being sufficiently charged. Failure to do so may result in either loss of the transponder or intermittent (or zero) function which could lead to non-classification.

In case a transponder failure is identified by the Officials during a race, the driver will be allowed to continue under normal racing conditions (see also 2.6.4). The decision on final classification will then be referred to the Stewards along with a report of what caused the failure and, where possible, the real-time finishing position as confirmed by a Judge of Fact.

It is not the responsibility of the Officials to monitor individual timing issues. Where such issues are not identified during the race, the final classification will remain as per the official timing system report.

4.4 – RECORDING EQUIPMENT:

The use of personal kart/helmet mounted cameras will not be permitted. Exceptionally, and by special arrangement, drivers may be selected by the organisers to carry kart-mounted cameras during sessions. These will be fitted on the Pre-Grid and removed in Parc Fermé.

All footage will remain the intellectual property of Al Ain Raceway and ATC UAE. Tampering or interfering with the fitted equipment by a driver or team member is a sanctionable offence and will be referred to the Stewards and ATC UAE.

4.5 – FLOOR MATS:

The use of floor mats (or suitable equivalent floor covering) beneath karts when work is being carried out is mandatory throughout practice and race days. This prevents problematic, unsightly and costly tarnishing of paddock areas belonging to the host venue. The organisers reserve the right to eject from the paddock area any competitor who fails to observe this ruling and/or may insist that the offender purchase/hire appropriate floor protection if immediately available.

5 - TECHNICAL REGULATIONS

5.1 – GENERAL:

The UAE RMC Technical Regulations 2016/17 also apply to the UAE RMC. Amendments may be made at anytime by AARKC in collaboration with ATCUAE by way of Competitor Bulletins or Event Supplementary Regulations which will be posted on the Official Notice Board at each event.

CIK Regulations apply to all safety issues except where otherwise stated.

Karts are only allowed to race if they are in a condition which meets CIK safety standards and if they comply with the regulations. They must be maintained in such a way as to not represent a danger to the driver or other participants/spectators.

Remember **"ANYTHING WHICH IS NOT EXPRESSLY ALLOWED IS FORBIDDEN."**

5.2 – KARTS:

5.2.1 – Chassis:

Chassis' with CIK 2006/2009/2012/2015 Homologation and approved by Al Ain Raceway (in collaboration with ATC UAE) will be sanctioned to race. Rotax RM1 chassis' can only be used with all original components mounted.

Please note that chassis' produced by Intrepid Driver Program are NOT permitted for use, with the exceptions of 'Rocket DD2' chassis numbers 0028-0032 and 'Sirius' chassis number 0045.

Drivers will be allowed only one chassis per meeting. In the exceptional case of the chassis sustaining irreparable damage during the course of the meeting (i.e. in the opinion of the Technical Scrutineer it is neither safe nor practical to repair), at the discretion of the Clerk of the Course (in consultation with the Stewards), a replacement chassis may be used. This chassis must first be inspected and approved for use by the Scrutineers.

Front brakes are mandatory in the DD2 and DD2 Master classes but are prohibited in all other classes.

5.2.2 - Bumpers and Bodywork:

Only CIK homologated bumpers and bodywork are legal to use. Side pod bars must be securely fastened. Use of the CIK front fairing Mounting kit will be determined by a Supplementary Regulation or an official Bulletin.

5.2.3 – Wet Race:

CIK Technical Regulation 2.7.1.4 applies: "In the case of a 'wet race', side body work may not be located outside the plane passing through the outer edge of the rear wheels."

5.2.4 – Rims:

With the exception of the Micro MAX class wheel rims must be fitted with a minimum of three bead retaining screws.

5.2.5 - Fuel Tank:

No coverings may be placed on or around fuel tank, i.e. silver reflective foil.

5.2.6 – Engines:

Al Ain Raceway is appointed as the authorised Distributor for Rotax Kart Products in the United Arab Emirates, and is an authorised Service Centre and the only sealing authority.

Only genuine Rotax components that are specifically designed and supplied for the FR125 MAX, MAX EVO, DD2 and DD2 EVO engines are legal. These parts must be obtained from Al Ain Raceway.

Only engines sealed by Al Ain Raceway will be deemed legal. Any engines without a valid Al Ain Raceway seal and accompanying "Rotax Engine Identity card" issued by Al Ain Raceway will not be permitted for use.

Loss of the "Rotax Engine Identity card" will necessitate a replacement and an accompanying fine of AED 500.

A AED 250 penalty will be imposed on any driver who is unable to present his/her Rotax Engine Identity Card during a race event when asked to do so by one of the Officials.

A maximum of TWO engines per driver per meeting will be allowed.

In exceptional cases, (e.g. engine(s) submitted at Scrutineering experience technical failure) drivers may have the option of using a third engine but this is at the discretion of the Clerk of the Course in consultation with the Stewards and the event organisers.

Engines originating from anywhere other than Al Ain Raceway will be rejected and not permitted for use. Engine seals may only be removed/replaced by Al Ain Raceway. Engines with a broken/invalid seal may not be used. In the unlikely event of a broken seal it must remain attached to the engine for inspection to be made by Al Ain Raceway.

IF AL AIN RACEWAY SUSPECTS THAT AN ENGINE HAS BEEN TAMPERED WITH, THAT ENGINE WILL BE EXCLUDED FROM COMPETITION AND WILL NOT BE RE-SEALED UNDER ANY CIRCUMSTANCES.

5.2.7 – Spark Plugs

The only spark plugs acceptable are Denso Iridium IW (27, 29, 31, 34).

5.2.8 – Ballast:

The mass of the kart may be adjusted with one or several ballasts subject to their being solid blocks, each weighing no more than 5kg, fixed to the chassis or to the seat (NOT the bodywork) by means of tools with at least two bolts of minimum diameter 6 mm.

Reinforcement plates (min thickness 1.0mm, min diameter 20mm) are mandatory for the fixation of the ballast.

5.2.9 - Fuel Pump:

For FR125 MAX, FR125 Junior MAX, FR125 Mini MAX and FR125 Micro MAX the fuel pump must be located on the air box support bracket.

5.2.10 – Chain Guard:

In all categories without a gearbox, a chain guard is compulsory and must be an effective protection over the top and both sides of the exposed chain and sprocket, and extend to at least the lower plane of the rear axle.

5.2.11 – Seat and Supports:

The seat must be tightly fastened to the chassis seat supports at all times. This must incorporate a washer of minimum diameter 40mm between the seat and the support at each mounting point. This also applies to additional seat stays which, if used, must be tightly anchored at both ends.

5.3 – 'ALL ENGINES EQUAL' SUBSTITUTION SCHEME:

In the interests of promoting fair play and eliminating any murmurings of discontent, all competitors are bound to accept the 'All Engines Equal' substitution scheme.

5.3.1 – Procedure:

The procedure is as follows:

- (1) During a race meeting, a competitor shall formally advise the Chairman of the Stewards in writing that they wish to invoke the right to 'substitute' the engine of another competitor. This signed, written statement must include all details relevant to the engine in question (including ownership thereof), together with his/her personal details for review by the Stewards. This must be submitted in person before the end of the Final race and MUST be accompanied by a **non-refundable** cash amount as listed below (also includes MAX EVO variants):
 - 125 MAX DD2 AED 17,000
 - 125 MAX AED 16,000
 - 125 JUNIOR MAX AED 15,000
 - 125 MINI MAX AED 15,000
 - 125 MICRO MAX AED 12,000
- (2) At the conclusion of the Final race, the engine will be detained in Parc Fermé. Once the Chief Scrutineer has completed his technical checks, he will arrange for the engine to be removed from competition and passed, with its engine ID card, to Al Ain Raceway as the UAE's authorised Distributor.
For clarification, 'engine' includes all parts contained within the engine seal plus e-starter (294802), pick-up sensor (265560), clutch assembly (complete – as it finished racing, including front sprocket), clutch cover (260772), exhaust socket (273190 or equivalent), exhaust valve assembly (MAX and DD2 only, from exhaust valve 253725 to adjustment screw 241220 or equivalent).
- (3) A brand new sealed engine and accompanying ID Card (with new parts as specified in (2) above), of the latest available specification, with full manufacturer's warranty, will be provided as replacement by Al Ain Raceway.
- (4) The engine that was substituted will be completely disassembled and inspected by Al Ain Raceway before being removed from competition as a complete unit.

5.3.2 – Conditions:

The above procedure must be followed in full and within the correct time parameters.

The engine substitution cannot be enforced before the end of the Final race.

Engine substitutions can only be enforced if the application is received from a registered competitor/Entrant of AARKC from the same class (same engine type).

A competitor may only apply for an engine substitution ONCE during the season.

6 - SAFETY EQUIPMENT

All safety wear (helmet, gloves, boots, race suits) must be approved under the CIK Karting Technical Regulations, Article 3.

6.1 – Crash Helmet:

The driver must wear a helmet with efficient and unbreakable protection for the eyes.

Helmets must comply with the below standards for drivers under 15yrs:

Snell-FIA CMH (Snell-FIA CMS2007 and Snell-FIA CMR2007)

Helmets must comply with the below standards for drivers 15yrs +:

Snell Foundation K2005, SA2005, K2010, SA2010, SAH2010 and SA2015

Snell-FIA CMH (Snell-FIA CMS2007 and Snell-FIA CMR2007)

FIA 8859-2015, FIA 8860-2004 and FIA 8860-210

SFI Foundation Inc., Spec. SFI 31.1A and 31.2A

Dark visors are only permitted during daylight hours. Clear visors are mandatory after sunset. It is the responsibility of the competitor to ensure that sponsor sticker requirements are adhered to.



6.2 – Race Suit:

Fabric overalls must have "Level 2" homologation granted by the CIK-FIA, visibly bearing the CIK-FIA homologation number. They must cover the whole body, legs and arms. Overalls remain valid 5 years after their date of manufacturing and the homologation (period during which they can be produced) is valid for 5 years.

Leather overalls complying with the standards defined by the FIM are authorised. However, any competitor wearing leather overalls in UAE heat is liable to become a laughing stock and will not be helped out of the kart at the end of the race.

6.3 – Gloves:

Gloves must be in good condition and must completely cover the hands and fingers.

6.4 – Boots:

Boots must be in good condition and must cover and protect the ankles.

6.5 – Fire Extinguisher:

Competitors are required to have a fully serviceable fire extinguisher according to the ATC UAE (CIK-FIA) minimum recommended standard. This must be indelibly marked to identify the competitor and must be presented for inspection at Scrutineering.

7 – REGULATORY AMENDMENTS

Al Ain Raceway Kart Club reserves the right to issue additional statements concerning the Rules and Regulations from time to time. All such statements will be issued to all registered competitors by way of Competitors' Bulletins at Race Meetings.

8 - ADVERTISING ON KARTS, OVERALLS AND HELMETS

Competitors will be obliged to carry official RMC stickers and sponsor logos on their karts, race suits and helmet. Any such advertising material will be provided by the Organisers along with instruction on positioning as necessary.

Competitors are responsible for the presentation and preservation of sponsor stickers/logos. The organiser will provide 1 complete set of logos to each competitor free of charge. Lost/damaged stickers must be replaced at the expense of the competitor.

Competitors may be required to remove decals/stickers and other advertising which may conflict with the series sponsors.

Competitors may be required to take part in further promotional activities at the rounds or the prize giving.

Prize winners may be obliged to wear a sponsor cap, if supplied by Race Organiser, during the award presentation. All drivers receiving awards at the post-race presentation should wear their race suit (zipped up with collar fastened) and race boots.

Failure to comply with the Organiser's instructions could lead to exclusion from the results/event.

9 – GENERAL SAFETY

- A. It is strictly forbidden for drivers to drive their karts in a direction opposite to that of the race, unless this is strictly necessary to remove the kart from a dangerous situation.
- B. During each on-track session of the Race Meeting, drivers may use the track only and must at all times observe the dispositions of the Code relating to driving on circuits. The circuit is defined by the white lines on both sides of the track. Drivers are allowed to use the whole width of the track between these lines. If the four wheels of a kart are outside these lines, the kart is considered as having left the track.
- C. During a race a kart alone on the track may use the full width of the said track. However, as soon as it is caught up by a kart which is either temporarily or constantly faster, the driver is not allowed to move from one side to the other or make a move sideways in order to prevent a legal overtaking manoeuvre when the other competitor is already alongside.

- D. Curves, as well as the approach and exit zones thereof, may be negotiated within the limits of the track. Overtaking, according to the circumstances, may be done either on the right or on the left. However, manoeuvres liable to hinder other drivers such as premature or dangerous changes of direction, more than one change of direction or deliberate crowding of karts towards the inside or the outside of a curve, are strictly prohibited and shall be penalised, according to the significance and repetition of the offences, by penalties ranging from a fine to exclusion from the race. The repetition of dangerous driving, even involuntary, may result in the exclusion from the race.
- E. During each on-track session of the Race Meeting, a kart that stops must be removed from the track as rapidly as possible in order for its presence not to constitute a danger or be an impediment for other drivers. If the driver is unable to remove the kart from a dangerous position by driving it, he/she will be required to exit the kart when it is safe to do so and remove it to a place of safety. Marshals may assist if instructed to do so by the Clerk of the Course (see 2.8.4.1).
Except for medical or safety reasons, the driver must stay close to his kart until the end of the Race.
- F. If a repair area is provided, any repairs with tools are banned outside the zone. It is forbidden to take any tools and/or spare parts on board the kart. The driver can receive help only in the Repairs Area determined by the Supplementary Regulations or during the Briefing.
- G. Except in cases expressly provided for by the Regulations or by the Code, no one except the driver is authorised to touch a stopped kart before reaching the scales.
- H. When the track is closed by the Race Direction after the Qualifying/Race finish (until all concerned karts, whether they are mobile or not, have arrived at the scales or at the Parc Fermé) no one is allowed to access the track, with the exception of Marshals carrying out their duties and of drivers when they are driving.
- I. A speed limit of 5mph is imposed in the pit lane at all events. Any driver deemed to be exceeding this speed limit will be liable to sanctions provided for in the Regulations.
- J. If a driver is involved in a collision, he/she must not leave the circuit without the Stewards' agreement.
- K. No driver may leave the Parc Fermé Area without permission from the Chief Scrutineer.
- L. The driver of any kart leaving the race shall signal this intention in good time and is responsible for ensuring that the manoeuvre is carried out safely and as near as possible to the Pit Entry.
- M. Any driver who intends to leave the track by means of the Pit Lane shall demonstrate his/her intention in due time and shall ensure that he/she does so safely.
- N. In each session of the Race Meeting, drivers must at all times wear the full equipment defined under Art.6 of these Regulations (Art.3 of the CIK-FIA Technical Regulations).
- O. It is forbidden to circulate with motorbikes, scooters or any other motorised devices in the Paddock. This applies to skateboards, bikes/scooters, Segways, wheelbarrows, pogo-sticks and other such equipment by extension. Space hoppers are permitted. The driving of karts in the Paddock Area is forbidden under all circumstances.
- P. In the unusual case of rain, slick tyres will continue to be used. Racing will continue as normal at the discretion of the Race Director or Clerk of the Course in collaboration with the Chairman of the Stewards. Normally, racing will only be halted if driving conditions become dangerous, e.g. in the case of standing water. It is assumed that drivers will be able to recognise wet conditions due to the appearance of rain drops on their visors.
- Q. It is the Entrant's responsibility to ensure that all persons concerned by his/her Entry observes all the provisions of the Code, the Technical Regulations and the Sporting Regulations. If an Entrant is unable to be present in person at the event he/she must nominate a representative in writing. The person having charge of an entered kart during any part of an event is responsible jointly with the Entrant and/or separately for ensuring that the provisions are observed.

- R. Entrants must ensure that their karts comply with the conditions of conformity and safety throughout the Event. The presentation of a kart for scrutineering will be deemed an implicit statement of conformity.
- S. It is imperative that, when seated in the kart, drivers are positioned so as to enable full and proper use of the steering wheel and pedals without overstretching. Further, the driver's eye-level in relation to the top of the steering wheel and Nassau Panel must permit adequate visibility straight ahead.

10 – CODE OF CONDUCT

- A. All participants must play by the rules and respect race officials and their decisions.
- B. All participants must respect the rights, dignity and value of their fellow participants regardless of gender, ability, physical appearance, cultural background or religion.
- C. All participants must take responsibility for their actions at all times and communicate behavioural responsibilities to members of their family, team and support crew.
- D. All participants are required to display courtesy and etiquette to other members and participants in training, testing and race events. Any disputes or problems that may arise during an event must be addressed in a respectful manner to the appropriate person (official) at the event.
- E. Drivers must take the time to read and fully understand the posted rules, regulations and conditions for any race event prior to its commencement. Requests for clarification of such regulations should be asked during the Drivers' Briefing.
- F. All participants must have respect for the environment, the hosting venue, spectators and the surrounding inhabitants. Responsibility must be taken to reduce excessive noise and keep all areas that are used as clean and presentable as possible.
- G. Drugs and alcohol are strictly prohibited during training, testing and races. Consumption of such substances during these times is a serious offence. Offenders will be excluded from the event and face further disciplinary action.
- H. Abusive comments on any social media platform (Facebook, Twitter etc.) or public forum are completely forbidden. This applies to competitors, teams, officials, organisers and any person associated with the series and the sport in general. Competitors are strongly advised to guard against participation in contentious, divisive and potentially damaging conversations and will be held liable for their actions.

11 – INCIDENTS

An "Incident" means a fact or a series of facts involving one or several drivers (or any Driver's action reported to the Stewards by the Clerk of the Course or noted by the Stewards and reported to the Clerk of the Course for investigation), who:

- provoked the stopping of a race in application of article 142 of the code,
- violated these Sporting Regulations or the Code
- jumped the start
- did not respect flag signalling
- caused one or several karts to take a false start
- caused a collision
- forced another driver out of the track
- illegally prevented a legitimate passing manoeuvre by a driver
- illegally impeded another driver during a passing manoeuvre
- leaving or working on their kart in a dangerous position

The Stewards shall inflict a time or position penalty on any driver having caused an incident. If the incident was caused during a qualifying practice session, they shall proceed to the cancellation of the three fastest times which he/she achieved in the session concerned. However, considering its serious nature, the stewards may decide, instead of (or as well as) the time/position penalty, of a sanction among those provided for in the penalty scale of Article 153 of the Code.

Typical penalty scenarios can be seen in Article 12.



12 – PENALTY CATALOGUE

A. FALSE START

TYPE A – A kart on the formation lap approaching the start line has two wheels on or outside the tram lines before the red lights are switched off to start the race (as depicted by kart number 2 in the right illustration).

Penalty: 3 seconds

TYPE B – A kart on the formation lap approaching the start line has all four wheels outside the tram lines before the red lights are switched off to start the race.

Penalty: 10 seconds

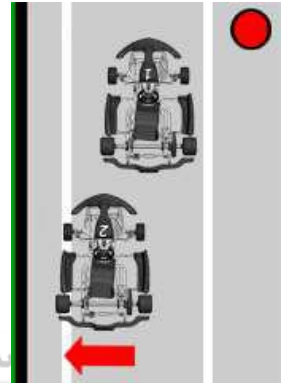

B. JUMP START

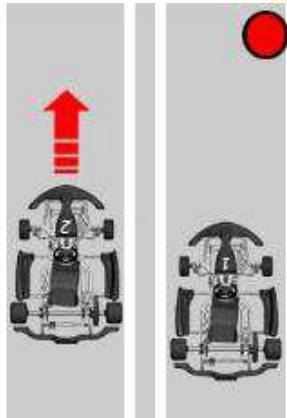

A **JUMP-START** is declared by a Judge Of Fact when a kart either (1) has accelerated prematurely before crossing the yellow acceleration line and/or before the red race start lights have been switched off, and/or (2) is ahead of its prescribed position at the time the start signal is given (as depicted by kart number 2 in the left illustration).

Penalty: 10 seconds

Note: The penalty may be applied against the offending driver(s) even if the start is aborted and declared a "FALSE START". This is at the discretion of the Clerk of the Course.

If one driver is guilty of causing multiple false starts then the race direction may apply a penalty at their discretion which could be relegation to the back or a time penalty as specified above.

C. CUTTING-IN

This is where a kart (kart number 1 in the illustration) is positioned on the outside of kart 2 and either partially/completely cuts across the racing line of, or otherwise impedes, kart 2 during a legitimate overtaking manoeuvre. This applies to the corner entry, apex and exit.

For 'cutting in' to be considered, kart 2 must be positioned so that its front wheels are at least alongside the rear wheels of kart 1 (as depicted in the right illustration).

An advantage is gained if (either/or):

- Kart 2 suffers a loss of position or fails to finish as a direct consequence of the manoeuvre.
- Kart 2 suffers damage which results in a loss of position or is forced to retire from the race on the same lap.
- Kart 1 maintains his/her position when he/she would have otherwise lost it.

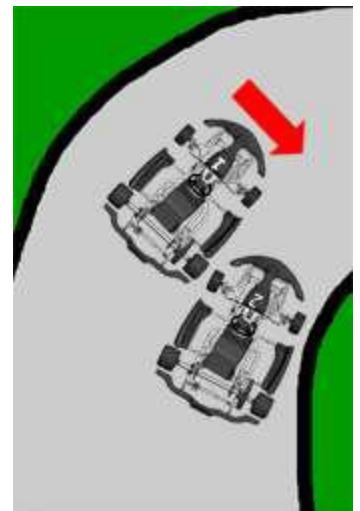

Penalty (no advantage gained):
Penalty (advantage gained)

Warning or up to 10 seconds
Either 10 seconds or up to 10 positions

Note: The penalty shall be applied irrespective of whether there was any contact between the karts or not.

D. DIVING UP THE INSIDE

This is where a kart (*kart 2 in the illustration*) attempts to overtake kart 1 on the inside despite there being insufficient track space available (including the inner kerbs and areas outside the track limits) to safely complete the manoeuvre. The position of each kart relative to each other is irrelevant.

An advantage is gained if (either/or):

- Kart 2 gains a position
- Kart 1 suffers a loss of position or fails to finish as a direct consequence of the manoeuvre.
- Kart 1 suffers damage resulting in (a) loss of position(s) or is forced to retire from the race on the same lap.

Penalty (no advantage gained): Warning or up to 10 seconds

Penalty (advantage gained): Either 10 seconds or up to 10 positions

Note: The penalty shall be applied irrespective of whether there was any contact between the karts or not and regardless of whether the overtaking manoeuvre was completed or not.

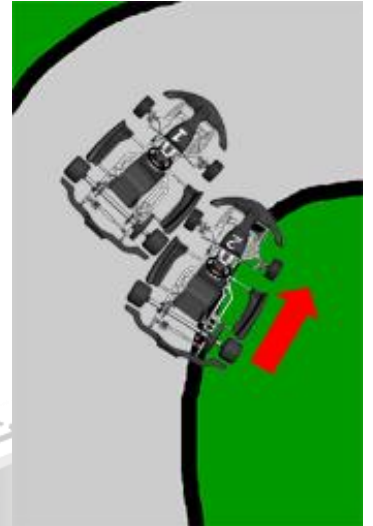

E. CROWDING, PUSHING or SQUEEZING

This is where one kart (*kart 1 in the right illustration*) forces kart 2 wide towards the track limits or partially/completely beyond the track limits.

The proviso is that kart 2 is positioned so that its front wheels are at least alongside the rear wheels of kart 1 (as depicted in the illustration).

An advantage is gained if (either/or):

- Kart 1 maintains his/her position when he/she would have otherwise lost it.
- Kart 2 suffers a loss of position or fails to finish as a direct consequence of the manoeuvre.
- Kart 2 suffers damage resulting in (a) loss of position(s) or is forced to retire from the race on the same lap.

Penalty (no advantage gained): Warning or up to 10 seconds

Penalty (advantage gained): Either 10 seconds or up to 10 positions

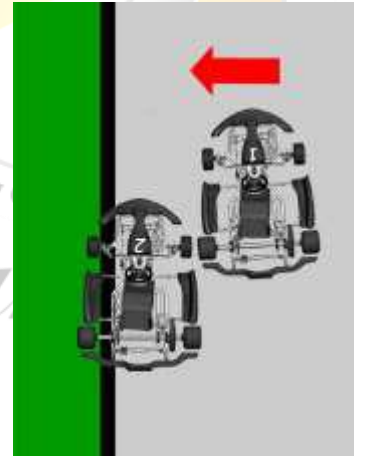

F. BUMPING or CONTACT

This is where one kart (*kart 2 in the right illustration*) causes avoidable contact with another kart (involving either front to rear or side-to-side impact).

Only the consequences of the impact are relevant in judging whether an advantage has been gained or not. The severity of the impact is largely inconsequential.

An advantage is gained if (either/or):

- Kart 2 gains a position and the previous order is not restored during the same lap.
- Kart 1 suffers a loss of position or fails to finish as a direct result of the contact.
- Kart 1 suffers damage resulting in (a) loss of position(s) or is forced to retire from the race on the same lap.

Penalty (no advantage gained): Warning

Penalty (advantage gained): Either 10 seconds or up to 10 positions

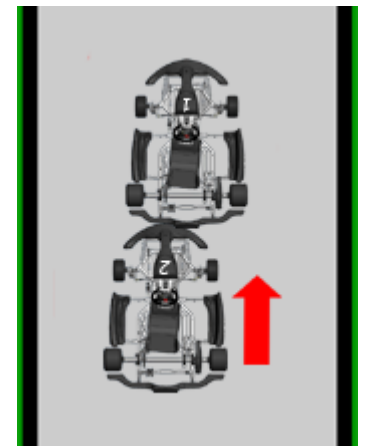

G. SHORT-CUTTING OR EXCEEDING CIRCUIT LIMITS

This is where one kart (kart 2 in the right illustration) exceeds the track limits completely and returns to the racing surface at a different point further along the track either via a shorter distance or with greater speed as a result of the breach (e.g. utilising run-off areas to gain time). The reasons for leaving the track are irrelevant.

An advantage is gained if (either/or):

- Kart 2 gains a position and/or time which cannot be redressed during the same lap.
- Kart 2 maintains his/her position when he/she would have otherwise lost it.
- Another kart is impeded or otherwise handicapped by a kart re-joining the circuit after exceeding the track limits.
- Another kart suffers (a) loss of position(s) or is forced to retire from the race as a direct result of the re-entry of a kart which has exceeded the track limits.

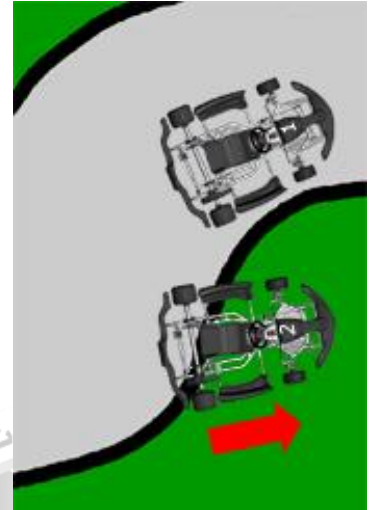

Penalty (no advantage gained):

Warning

Penalty (advantage gained)

Either 10 seconds or up to 10 positions

H. WEAVING or BLOCKING

This is where a kart (kart 1 in the right illustration) changes its lateral position / racing line on a straight by more than a kart's width, twice or more.

The distance between the karts involved and whether the chasing kart would have been able to complete an overtaking manoeuvre is irrelevant.

An advantage is gained if (either/or):

- Kart 1 maintains his/her position when he/she would have otherwise lost it.
- Kart 1 performs such a manoeuvre more than once during the same race.

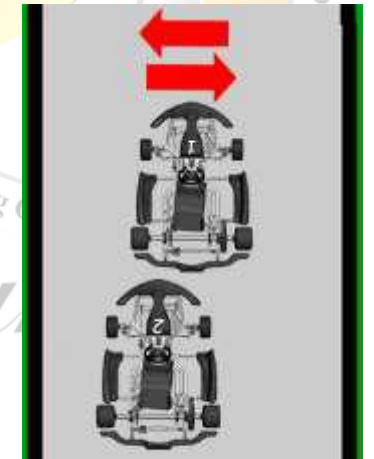

Penalty (no advantage gained):

Warning

Penalty (advantage gained)

Either 10 seconds or up to 10 positions

I. TECHNICAL INFRINGEMENT

This occurs when a kart and/or engine does not meet the stipulated technical regulations or specifications.

It is irrelevant if the technical infringement was discovered before, during or after a qualifying session or a race, and whether the technical infringement would have led to any advantage being gained.

Only the condition and specification of the kart / engine at the time of the official examination will be considered.

Typical examples of a technical infringement might include:

- Being underweight
- Using incorrect fuel, oil, coolant etc.
- Using modified parts
- Use of unmarked tyres.

Penalty:

Exclusion



In case of a protest against the eligibility of another competitor or their equipment, such a protest must be lodged within 30 minutes of the alleged ineligibility becoming apparent.

J. FORMATION LAP OFFENCES

- (i) A kart on the formation lap improves its starting position after having crossed the red formation line and before the start signal is given (as depicted by kart number 2 in the right illustration).

Penalty: Exclusion

- (ii) A kart on the formation lap attempts to make up time or positions by taking a short-cut (any course other than the track used during the race) to regain its original position (see Article 2.8.3).

Penalty: Exclusion

- (iii) A driver fails to remove his/her kart to a safe position in a timely manner after stopping on the formation lap and being unable to continue (see Article 2.8.3).

Penalty: Grid penalty in future race

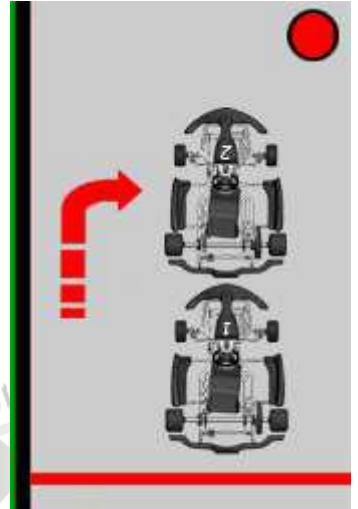

K. IGNORING FLAG SIGNALS

This is self-explanatory and is when a driver fails to observe the requirements of a particular flag being displayed by race officials.

The type of flag and the reason(s) why the flag was not obeyed is irrelevant along with whether any advantage was gained or not.

Typical examples of ignoring flag signals might include:

- Overtaking under a yellow flag (as depicted by kart number 2 in the right illustration).
- Continuing to race after receiving a black/orange or black flag or red flag.
- Failing to comply with the blue flag requirements when being lapped.

Penalty: Exclusion

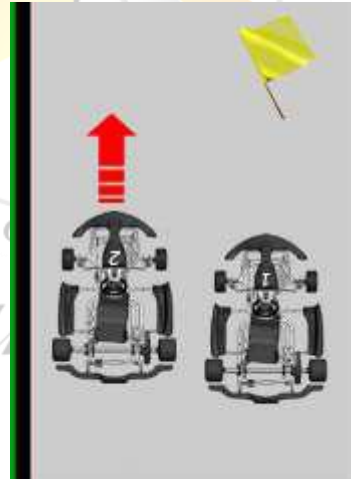

L. CAUSING A COLLISION

This is where one kart, regardless of its position on or off the track, and regardless of the proximity (or not) of other karts, and regardless of whether or not any contact occurred, is deemed to have been responsible for causing a collision.

Only the consequences of the incident are relevant in judging whether an advantage has been gained or not.

An advantage is gained if (either/or):

- The driver gains time or (a) position(s) and the previous order is not restored during the same lap.
- Another driver(s) suffers a loss of time or position or fails to finish as a direct result of the incident.

Penalty (no advantage gained): Warning/Reprimand

Penalty (advantage gained)

Either 10 seconds or up to 10 positions



M. FRONT FAIRING MOUNTING KIT

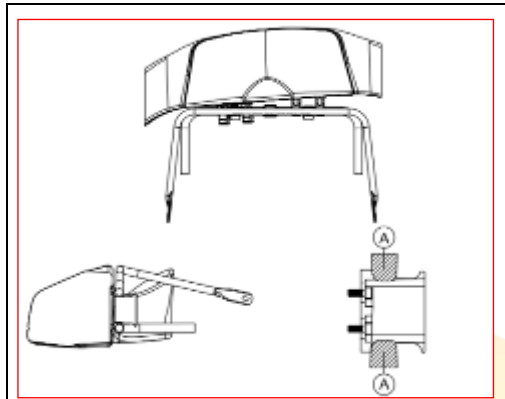

THE FRONT FAIRING IS NOT IN AN ACCEPTABLE POSITION IF ANY PART OF THE TUBES OF THE FRONT BUMPER ARE IN THE AREA 'A'.

Where the CIK-homologated detachable front fairing mounting kit is used, it must at all times during live sessions be fitted and maintained in the correct position in accordance with Competitor Bulletin REF 16100501.

TYPE A – DETACHMENT – A Judge of Fact reports the front fairing of a kart to be in an unacceptable position as defined by Bulletin REF 16100501 (and shown in the left illustration)

Penalty (Race): 10 seconds

Penalty (Qualifying): Deletion of fastest lap

Note: The above penalty is mandatory and indisputable for front fairing non-compliance only. Drivers may be referred to the Stewards for offences that gave rise to the non-compliance.

TYPE B – ILLEGAL REPLACEMENT – A competitor replaces/refits/resets the front fairing to an 'acceptable' position in advance of formal inspection in Parc Fermé (in an attempt to avoid the sanction detailed in TYPE A above).

Penalty: Exclusion

NOTE:

The above examples provide a guide as to how penalties are applied to competitors for specific offences. However, each incident must, by necessity, be judged on its own merits and additional penalties may be applied by the Senior Officials as they deem fit, with harsher penalties likely for repeat offenders.

Where appropriate penalties cannot be applied to the session/race in which the offence occurs the Senior Officials reserve the right, at their sole discretion, to carry forward a representative penalty to the driver's next session, race or event. This may involve invoking grid place penalties or alternative sanctions as circumstances dictate.

In all cases, the Clerk of Course / Stewards will formally notify the driver of the offence, the resulting penalty decision and the intention to carry forward the penalty to his/her next session, race or event.

Any driver/entrant refusing to sign a legitimate penalty notice may forfeit all Championship points gained during the event and may be subject to further sanctions.

SUMMARY OF PENALTIES

ARTICLE	OFFENCE	RECOMMENDED PENALTY
12A	2 WHEELS OUTSIDE TRAMLINES BEFORE START SIGNAL	3 s ADDED TO RACE TIME
	4 WHEELS OUTSIDE TRAMLINES BEFORE START SIGNAL	10 s ADDED TO RACE TIME
12B	JUMP START	10 s ADDED TO RACE TIME
12C	CUTTING IN - NO ADVANTAGE GAINED	WARNING OR UP TO 10 s
	CUTTING IN - ADVANTAGE GAINED	10 s OR UP TO 10 POSITIONS
12D	DIVING UP THE INSIDE - NO ADVANTAGE GAINED	WARNING OR UP TO 10 s
	DIVING UP THE INSIDE - ADVANTAGE GAINED	10 s OR UP TO 10 POSITIONS
12E	CROWDING, PUSHING, SQUEEZING - NO ADVANTAGE GAINED	WARNING OR UP TO 10 s
	CROWDING, PUSHING, SQUEEZING - ADVANTAGE GAINED	10 s OR UP TO 10 POSITIONS
12F	BUMPING CONTACT - NO ADVANTAGE GAINED	WARNING OR UP TO 10 s
	BUMPING CONTACT - ADVANTAGE GAINED	10 s OR UP TO 10 POSITIONS
12G	EXCEEDING CIRCUIT LIMITS - NO ADVANTAGE GAINED	WARNING OR UP TO 10 s
	EXCEEDING CIRCUIT LIMITS - ADVANTAGE GAINED	10 s OR UP TO 10 POSITIONS
12H	WEAVING/BLOCKING - NO ADVANTAGE GAINED	WARNING OR UP TO 10 s
	WEAVING/BLOCKING - ADVANTAGE GAINED	10 s OR UP TO 10 POSITIONS
12I	TECHNICAL INFRINGEMENT	EXCLUSION
12J	FORMATION LAP - GAINING POSITION AFTER RED LINE	EXCLUSION
	FORMATION LAP - TAKING A SHORT-CUT	EXCLUSION
	FORMATION LAP - LEAVING KART IN DANGEROUS POSITION	GRID PENALTY IN FUTURE RACE
12K	IGNORING FLAG SIGNALS	EXCLUSION
12L	CAUSING A COLLISION – NO ADVANTAGE GAINED	WARNING OR REPRIMAND
	CAUSING A COLLISION – ADVANTAGE GAINED	10 s OR UP TO 10 POSITIONS
12M	FRONT FAIRING MOUNTING KIT – DETACHED	10 S OR DELETION OF LAPTIME
	FRONT FAIRING MOUNTING KIT – ILLEGAL REPLACEMENT	EXCLUSION

NOTE THAT FOR OFFENCES COMMITTED DURING COMPETITIVE QUALIFYING SESSIONS , THE OFFICIALS MAY ALSO ELECT TO DISQUALIFY THE OFFENDER'S FASTEST LAP TIME(S) OR INVOKE A GRID PENALTY IN A FUTURE RACE(S).